

# HENGSTLER

## Operating Instructions **tico 735** - Single Preset Counter

### Introduction

Your Hengstler **tico 735** Single Preset Counter is one model in a family of 1/8 DIN units which offers breakthrough display technology as well as easy-to-program single-line parameters.

Designed to provide instant visual feedback regarding an application's key input value, the **tico 735** not only has a 18 mm high LED display, but also the ability to change display colour based on process status (programmable parameter in Operation Mode). Easy programming is made possible via a help function and a secondary legend display.

This manual will guide you through the installation and wiring of your **tico 735** unit with information on proper panel mounting and rear terminal layout and wiring instructions. In addition, the instrument's operation and programming modes are thoroughly explained. The operation mode provides day to day operation and allows editing of preset values. The Program Mode enables the configuration of various parameters prior to initial operation. These parameters include those for basic configuration as well as other settable features which will enhance the functionality and usability of the device.

This manual also provides information on the **tico 735** Single Preset Counter's transistor and relay outputs, product specifications, and ordering information.



### Features

- Awesome 18 mm high digit LED display
- Programmable colour change display based on an event
- Programmable help function and secondary legend display
- Choice of NPN or PNP primary input
- Filter speed settable 20 Hz, 200 Hz, or 10 kHz
- Standard outputs: one NPN transistor & one relay
- Front panel reset enable and preset/alarm lockout
- Optional RS-485 plug in card

### Index

Safety Instructions .....	2
Installation.....	2
Panel mounting.....	2
Wiring.....	3
Operation.....	4
Front Panel .....	4
Operation Mode .....	5
Program Mode .....	6
Entering Program Mode and basic operation.....	6
Program Parameter Sequence .....	7
Technical Data.....	<b>Fehler! Textmarke nicht definiert.</b>
Ordering Information .....	<b>Fehler! Textmarke nicht definiert.</b>

## Safety Instructions



This symbol indicates passages in the text which you have to pay special attention to so as to guarantee proper use and preclude any risk.

- The range of applications for this product are industrial processes and controls, where the overvoltages applied to the product at the connection terminals are limited to values of the overvoltage category II.
- This device is made and tested according to the valid standards of technics and has left the factory in a perfect safety state. To keep this state and secure operation without danger, the user has to observe the safety and warning hints, contained in this operation manual.
- Assembling and mounting of electrical devices are restricted to be done by skilled electricians! Skilled electrician is, who can judge the tasks deputed to him and foresee possible dangers, due to his special education, knowledge and experience and consciousness of the pertinent standards.
- Mount devices are only allowed to be operated when mounted.
- Finger protection at connection part of mount devices is to be secured when mounting!
- While mounting the device, it must be secured that the requirements, which are asked for the device in the pertaining standards for safety, are not affected in a negative way, so reducing the safety of this mount device.
- Mounting and assembling of device needs observation of the specifications of the local Energy Suppliers.
- Before switching on, make sure that the power and control voltages are not exceeding the values in accordance with the technical data.
- If it is to be assumed that operation without danger is not further possible, the device must be put out of operation and secured from unintentional operation! It must be assumed that an operation without danger is not further possible,  
if the device shows damage  
if the device stops functioning  
after a longer stocking period under unfavourable conditions  
after heavy strain during transportation.
- If by a failure or a malfunction of the device, endangering of men or animals or damaging of facilities are possible, this must be avoided by additional safety measures (end switches, protection devices and etc.).
- Before opening any cover, the device must be switched voltagefree.
- Hengstler Counters are intended for industrial applications.
- The mounting environment and nearby cabling have an important influence on the EMC (noise radiation and noise immunity) of the counter. When putting into operation, the EMC of the whole installation (unit) has to be secured. In particular, the relay outputs are to be protected from high noise radiation by suitable wiring.

## Installation

### Panel mounting

The instrument can be mounted in a panel with a thickness of up to 12 mm. The cutout should be made based on the recommended panel opening illustrated in the drawing below.

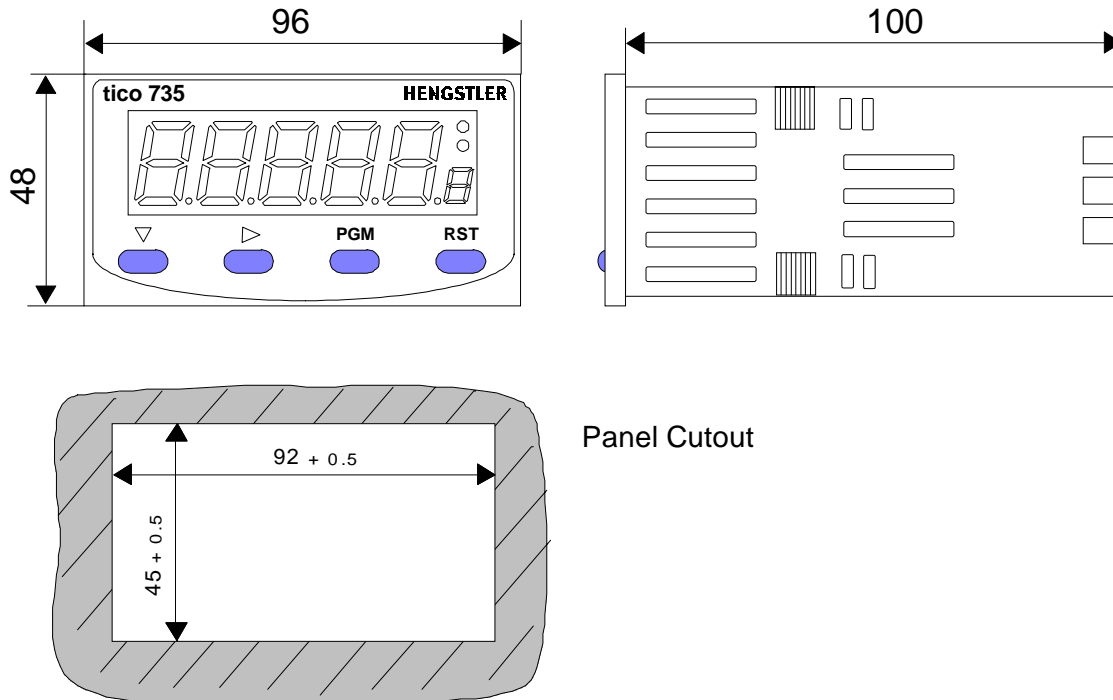

Panel Cutout

Insert the unit in the panel through the cutout. Ensure that the panel gasket is not distorted and the instrument is positioned squarely against the panel. Slide the mounting clamp into place on the instrument and push it forward until it is firmly in contact with the rear face of the mounting panel and the tabs on the bracket arm are seated in the mounting grooves on the side of the unit.

The electronic components of the instrument can be removed from the housing after installation without disconnecting the wiring. To remove the components, grip the side edges of the panel and pull the instrument forward. Take note of orientation of the unit for subsequent replacement in the housing.

## Wiring

### Rear Terminal Connections

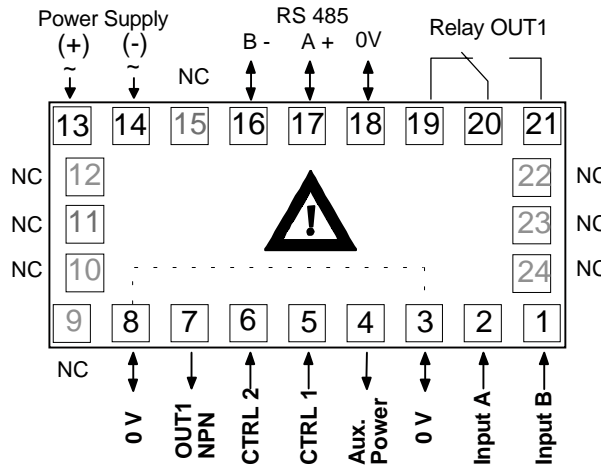

Danger! Hazardous voltage!

### Count Inputs

Terminal #2 is the connection for input A, which is programmable to be the primary input or channel A of an encoder input. Terminal #1 is the connection for Input B, which is programmable to be an incrementing input, a decrementing input, or channel B of an encoder input. The common connection for both input A and input B is terminal #3.

### Control/Digital Inputs

A contact closure or NPN signal can be used to activate preconfigured functionality. Terminal #5 is used for a remote reset function, while Terminal #6 is a security function, that when active, will prohibit entry into Program Mode. Terminal #8 serves as the common for both of these inputs.

### Auxiliary Power Output

A 12 VDC for powering external sensors and encoders up to 125 mA can be accessed by connecting the positive supply side of the sensor to Terminal #4 and the negative side to Terminal #8.

### Power Supply Input

For an AC powered unit, Terminal #13 serves as the line or hot side connection for AC powered units and as the positive side for DC powered units. The neutral side for AC powered units and the negative side for DC powered units are connected to terminal #14.

### Transistor Outputs

Your unit comes standard with an NPN output which is activated by the preset. Transistor output 1, which is tied to Preset 1 operation, is on Terminal #7. Terminal #8 serves as the common connection for the Transistor output.

### Relay Outputs

Your unit comes standard with a relay output which is tied to Preset 1 operation. Terminal #19 is NC, Terminal #20 is common and Terminal #21 is NO.

### Serial Communication

An RS-485 communication board, utilizing ASCII protocol, can be installed as an option. Terminals #16 and #17 serve as the B and A connections respectively, while terminal #18 is connected as the common.





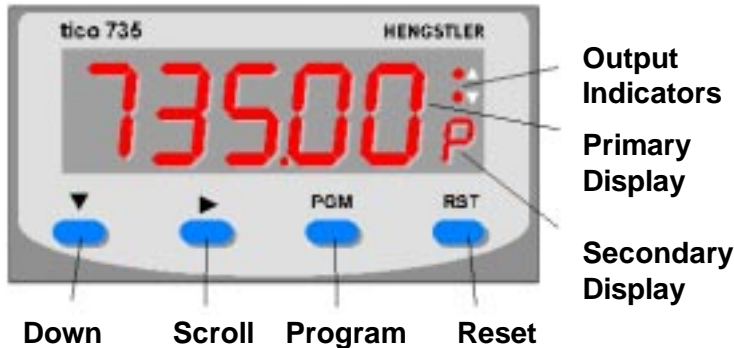

Terminals 9,10,11,12,15,22,23 & 24 are not used and must not be connected!

## Operation

### Front Panel



### Key functions

Key	Function
Down 	In <i>Operation Mode</i> : Used in Edit Operation to decrement the digit highlighted by the Scroll Key In <i>Program Mode</i> : Used in Edit Operation to decrement the digit highlighted by the Scroll Key, if the setting is a numerical value, or present the next in the series of choices for that parameter
Scroll 	In <i>All Modes</i> : Moves the unit into Edit Operation, which is indicated by the left most digit flashing. Successive presses of the key are used to move to the digit to be edited. Wrap around will occur from least significant digit to most significant digit.
Program 	In <i>Operation Mode</i> : Used to move between the count value display & the preset and to enter an edited preset value. Holding the key down for 3 seconds will cause the unit to enter Program Mode. In <i>Program Mode</i> : Used to move from one parameter to the next and enter the edited parameter values. Holding the key down for 3 seconds will cause the unit to return to Operation Mode.
Reset 	In <i>Operation Mode</i> : Resets the count value to zero (or to the preset in count down operation). This button can be disabled via the „Front Panel Reset Enable“ parameter in Program Mode. In <i>Program Mode</i> : No function
Down & Scroll 	In <i>All Modes</i> : Will abort an Edit Operation and return the preset/parameter to its previous value.

### Display functions

Display	Function
Primary	In <i>Operation Mode</i> : Default display is the count value. Can be scrolled using the program key to display the Preset 1 value. If the „Help“ function is enabled, this display will first show the parameter description for 3 seconds ( see example). In <i>Program Mode</i> : Displays the value or selection for the current parameter. If the „Help“ function is enabled, this display will first show the parameter description for 3 seconds ( see example).
Secondary	In <i>Operation Mode</i> : Indicates numerically if Preset 1 is being viewed on the primary display. This display is blank when Count Value is being shown. In <i>Program Mode</i> : Provides a 1 digit alpha or numeric character to indicate which parameter value is being shown on the primary display.
Output indicators	▲ illuminates when OUT1 is active ▼ no function

## Operation Mode

### Changing a Preset value (example)

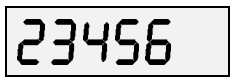
 Default display is the present count value.



 Pressing the Program Key will cause the display description to appear on the main display.\* If there is no key activity for 3 seconds, the primary display will switch back to the count value.

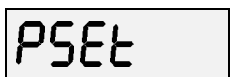

 Continued pressing of the Program Key will scroll to the Preset. (see parameter sequence below.) The full parameter description will appear on the main display.\*

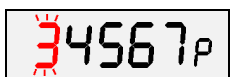

 To change the Preset value, press the Scroll Key. If there was no key activity for 3 seconds, the Preset value will appear (one digit description shown on secondary display); however, press the Scroll Key in order to edit. The unit will now be in Edit Operation as signified by the most significant digit flashing.\*\*



 Use the Scroll Key to move from left to right and highlight the digit that needs to be changed. Wrap around will occur from the least significant to the most significant digit.



 Use the Down Key to decrement the digit until the desired value appears. The display will wrap around from 0 to 9.

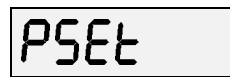

 After the desired digits have been changed, press the Program Key to enter the new value. The new value will appear on the main display without any flashing digits. Press the Program Key again and the parameter description will appear on the main display.

\* Parameter descriptions will not appear on the primary display if the „Help“ function has been disabled

\*\* Edit Operation cannot be accessed if the Preset Lock has been enabled in Program Mode

### Display Parameter Sequence

 **Count**  
*Function:* Displays the present count value.  
*Adjustment Range: 0 to 99999*

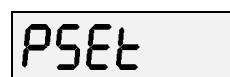

 **Preset 1**  
*Function:* Defines the value at which Output 1 will be activated  
*Adjustment Range: 0 to 99999*  
*Default Value: 10*

## Program Mode

### Entering Program Mode and basic operation

The Program Mode can be **accessed** from the Operation Mode by holding the Program Key for 3 seconds.

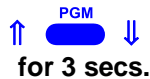

The Program Mode can be **exited** by holding the Program Key for 3 seconds or remove power from the unit and repower it.

After 90 seconds of key inactivity the unit returns to Operation Mode automatically.

The name of the first parameter will appear on the primary display.\*

3 secs. or



Successive presses of the Program Key will scroll the display through the remaining parameters in the Program Mode. To **exit** Program Mode, hold the Program Key for 3 seconds.

\* Parameter names will not appear on the main display if the „Help“ function has been disabled in Program Mode

### Edit Operation

Pressing the Scroll Key or no key activity for 3 seconds will display the value for that parameter. The secondary display will indicate the one digit identifier for that parameter. The digit in the secondary display will flash to indicate the unit is in Program Mode. If the Scroll Key was pressed (instead of waiting 3 seconds), the unit is in Edit Operation, as indicated by the MSD flashing. If there had been no key activity for 3 seconds, press the scroll key to enter Edit Operation (MSD flashing). Use the scroll and edit keys to change the value as in Operation Mode, described on page 5. Press the Program Key to enter any changes.

## Program Parameter Sequence

**CAL** C

**Calibration Factor**  
*Function:* Scales the input into engineering units by multiplying this value by the number of pulses received.  
*Adjustment Range:* 0.0001 to 9.9999  
*Default Value:* **1.0000**

**dEc** Pd

**Decimal Position**  
*Function:* Set the decimal point position for the count and preset displays. The setting of the decimal point merely switches the display dot and has no influence on the calibration calculation.  
*Adjustment Range:* 0 (no dp) to 0.0000  
*Default Value:* **0 (no dp)**

**count** c

**Count Mode**  
*Function:* Defines how the input pulses will be applied to the count value. Note: the sum of both input frequencies should not exceed 10 kHz.  
*Adjustment Range:*

<b>A+B</b> <span style="font-size: 2em;">c</span>	<b>A-b</b> <span style="font-size: 2em;">c</span>	<b>dir</b> <span style="font-size: 2em;">c</span>	<b>QuAd</b> <span style="font-size: 2em;">c</span>
A+B: Inputs on both the A & B channels increment the total	A-B: Inputs on the A channel increment the total, while inputs on the B channel decrement	Directional: When input B is inactive, input A increments. When input B is active, input A decrements.	Quadrature: The unit accepts a phased input from an encoder. The total increments when the A channel leads the B channel.

*Default Value:* **A+B**

**UP dn** u

**Count Direction**  
*Function:* Determines if the count value will increment from zero and change the state of the output at the preset (Up) or decrement from the preset and change the state of output at zero (Down)  
*Adjustment Range:*

<b>UP</b> <span style="font-size: 2em;">u</span>	<b>dn</b> <span style="font-size: 2em;">u</span>	<b>UP_Ar</b> <span style="font-size: 2em;">u</span>	<b>dn_Ar</b> <span style="font-size: 2em;">u</span>
Up: The unit will count up from zero and activate the output when the preset is reached	Down: The unit will reset to the preset value and The preset output will be activated when the count value reaches zero.	Up with Auto Reset: The unit will count up from zero and activate the output when the preset is reached, then automatically reset the count value to zero and continue operating.	Down with Auto Reset: The unit will begin at the preset. The preset output will be activated when the count value reaches zero. The unit will automatically reset its count value to the preset and continue operating

*Default Value:* **UP**

**InPut** u

**Input Type**  
*Function:* Programs the unit to match the electrical characteristics of the input signal  
*Adjustment Range:*

<b>Sin</b> <span style="font-size: 2em;">,</span>	<b>Src</b> <span style="font-size: 2em;">,</span>
Sinking: The unit will accept an NPN or dry contact input which sinks voltage to common	Source: The unit will accept an PNP input which sources voltage

*Default Value:* **Source**



SPEED F

## Filter Speed

*Function:* Enables the debounce filter of the counter to properly match the application

*Adjustment Range:*

20 F

200 F

10000 F

*Default Value:* 10000

20: The unit will accept up to 20 pulses per second. Generally used with contact inputs to eliminate false counts caused by contact bounce

200: The unit will accept up to 200 pulses per second. Generally used for higher speed contact inputs or to filter noise on electronic signals in low speed applications

10,000: The unit will accept up to 10,000 pulses per second. Generally used with high speed electronic inputs and encoders

PGM

OPt 1

## Output Time 1

*Function:* Sets the amount of time output 1 will be active once Preset 1 is reached

*Adjustment Range:* 00.00 (Latched) to 99.99

*Default Value:* 1.00

PGM

rS En r

## Front Panel Reset Enable

*Function:* Determines whether the Front Panel Reset key can be used to reset the count value.

*Adjustment Range:*

En r

dis r

*Default Value:*  
Enable

Enable: The count value can be reset while being viewed in Operation Mode by pressing the Front Panel Reset Key

Disabled: The Front Panel Reset Key is disabled and the count value can only be reset through the Remote Reset Input

PGM

CoMmS c

## Serial Communication enabled

*Function:* Activates the RS-485 communication option board.

*Adjustment Range:*

nonE c

F it c

*Default Value:* If ordered from the factory with the RS-485 board, the default will be „Fitted“. If the board is installed in the field, this parameter will need to be changed from its default of „none“.

None: no communication board installed

Fitted: A communication board is installed in the unit

PGM

Addr A

## Communication Address

(Appears only if communication board is installed and activated)

*Function:* Defines the unique communication address of the counter

*Adjustment Range:* 1 to 99

*Default Value:* 1

PGM

bAud b

## Baud Rate

(Appears only if communication board is installed and activated)

*Function:* Selects the serial communication speed

*Adjustment Range:*

1200 b

2400 b

4800 b

9600 b

1200 BPS

2400 BPS

*Default:* 4800 BPS

9600 BPS

PGM

Color o

## Display Colour Change

*Function:* Defines the colour of the display for prior to and after the preset value is reached

*Adjustment Range:*

rEd o

GrEEen o

Gr\_rd o

rd\_Gn o

Red: The display will always be red

Green: The display will always be green

Green to Red: The display will be green prior to the Preset value being reached. It will turn red after Preset has been reached

Red to Green: The display will be red prior to the Preset value being reached. It will turn green after the Preset has been reached

*Default Value:*

**Green to red**

PGM

Lock P

## Preset Lock

*Function:* Determines whether the Preset Value can be changed via the front panel.

*Adjustment Range:*

En P

dis P

*Default Value:* **Disable**

Enable: Preset value can be viewed and changed

Disabled: Preset value is read only

PGM

HELP h

## Help Prompt

*Function:* Determines whether the multi-character parameter name will appear on the main display for 3 seconds prior to the parameter value appearing.

*Adjustment Range:*

HLP Y h

HLP N h

*Default Value:*  
**Help Yes**

Help-Yes: Multi character parameter descriptions will appear on the primary display. The value associated with that parameter will appear by pressing the scroll key or waiting for 3 seconds

Help-No: Only the parameter values will appear on the primary display. The parameter can be identified by a single digit in the secondary display

## Technical Data

Display and Keyboard	Primary Display	Red/Green, 7 segment LED, 5 digits, height 18.5 mm
	Secondary Display	Red/Green, single digit 7 segment LED, height 7 mm
	Annunciators	1 red LED for OUT1
	Keyboard	4 rubber keys for programming and manual reset
Physical	Dimensions	DIN 48 mm x 96 mm, 110 mm total depth
	Mounting	Front panel mounting (mounting bracket supplied)
	Panel Cutout	45+0.5 mm x 92+0.5 mm, panel thickness max 12 mm
	Construction	Front carrier with circuit boards can be pulled out
	Terminals	Screw Type - combination head
Environmental	Power Supply	90 - 264 VAC 50/60 Hz (electrically separated from all inputs and outputs) or 20 to 50 VAC / 22 to 55 VDC
	Power Consumption	4 Watts
	Temperature	Operation: 0°C to +55°C (32°F to 131°F) Storage: -20°C to +80°C (-4°F to 176°F)
	Relative Humidity	20 % to 90 %, non-condensing
Approvals	Ratings	Frontpanel IP 66
	EMC Susceptibility	Complies with EN 50082-1/92-95
	EMC Emissions	Complies with EN 50081-1/92, -2/94
	Safety	DIN EN 61010 part 1; according to protection class II
	General	Overvoltage category II, Contamination level 2 UL, CUL
Count Inputs A and B	Active Edge	NPN or PNP programmable; capable of TTL; 30 VDC max
	when PNP	High $\geq 3.0$ V, Low $< 2.0$ V or open; 10 kOhm to 0V
	when NPN	High $\geq 3.0$ V or open, Low $< 2.0$ V; 4.7 kOhm to V+
	Count Frequency	20 Hz, 200 Hz or 10 kHz programmable
Control Inputs	CTRL1 (Reset)	NPN; High $\geq 3.0$ V or open, Low $< 2.0$ V; 4,7 kOhm to V+ edge sensitive; 25 ms min., max 30 VDC
	CTRL2 (Security Lockout)	NPN; High $\geq 3.0$ V or open, Low $< 2.0$ V; 4,7 kOhm to V+ level sensitive; 25 ms min.; max 30 VDC
Outputs	OUT1 NPN	Open Collector; 30 VDC max; 100 mA max; response time $< 75 \mu\text{s}$ at $< 2 \mu\text{s}$ cyclical accuracy
	OUT1 Relay	Changeover (Form C); 240 VAC / 3A or 115 VAC / 5A; pull-in time approx. 8 ms
	Sensor Power Supply	12 VDC (unregulated), 125 mA max; ripple $< 0.5$ V
RS-485 Option	Type	RS485, serial asynchronous, Open ASCII, Master-Slave, up to 99 zones
	Parameters	9600...1200 Bd, 1 start, 7 data, 1 stop, even parity

## Ordering Information

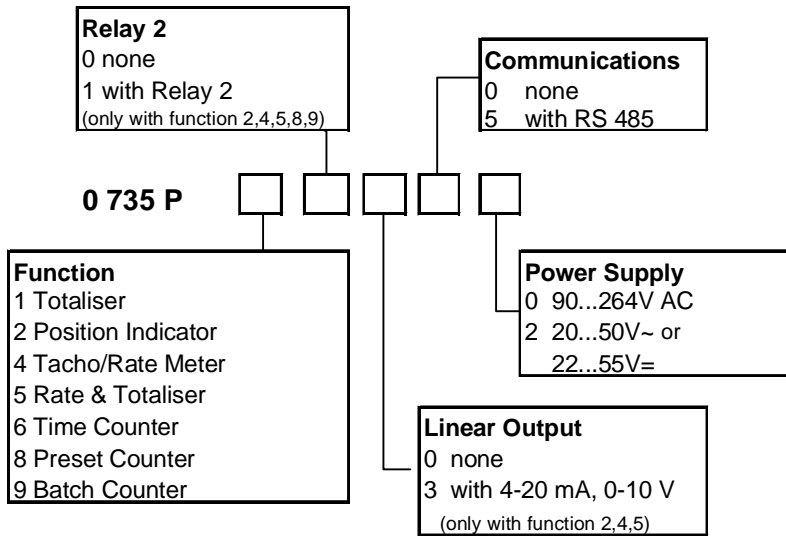

© 1998 HENGSTLER GmbH

This documentation may not be changed, amended, or copied without prior written consent of HENGSTLER GmbH, and may not be used in contradiction to this company's rightful interests.

## HENGSTLER

Hengstler GmbH  
Postfach 11 51  
D-78550 Aldingen  
Germany  
Tel. +49-7424-89 539  
Fax +49-7424-89 470

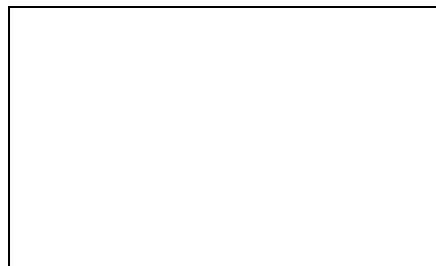

Member of the  **DANAHER CORPORATION** U.S.A